



































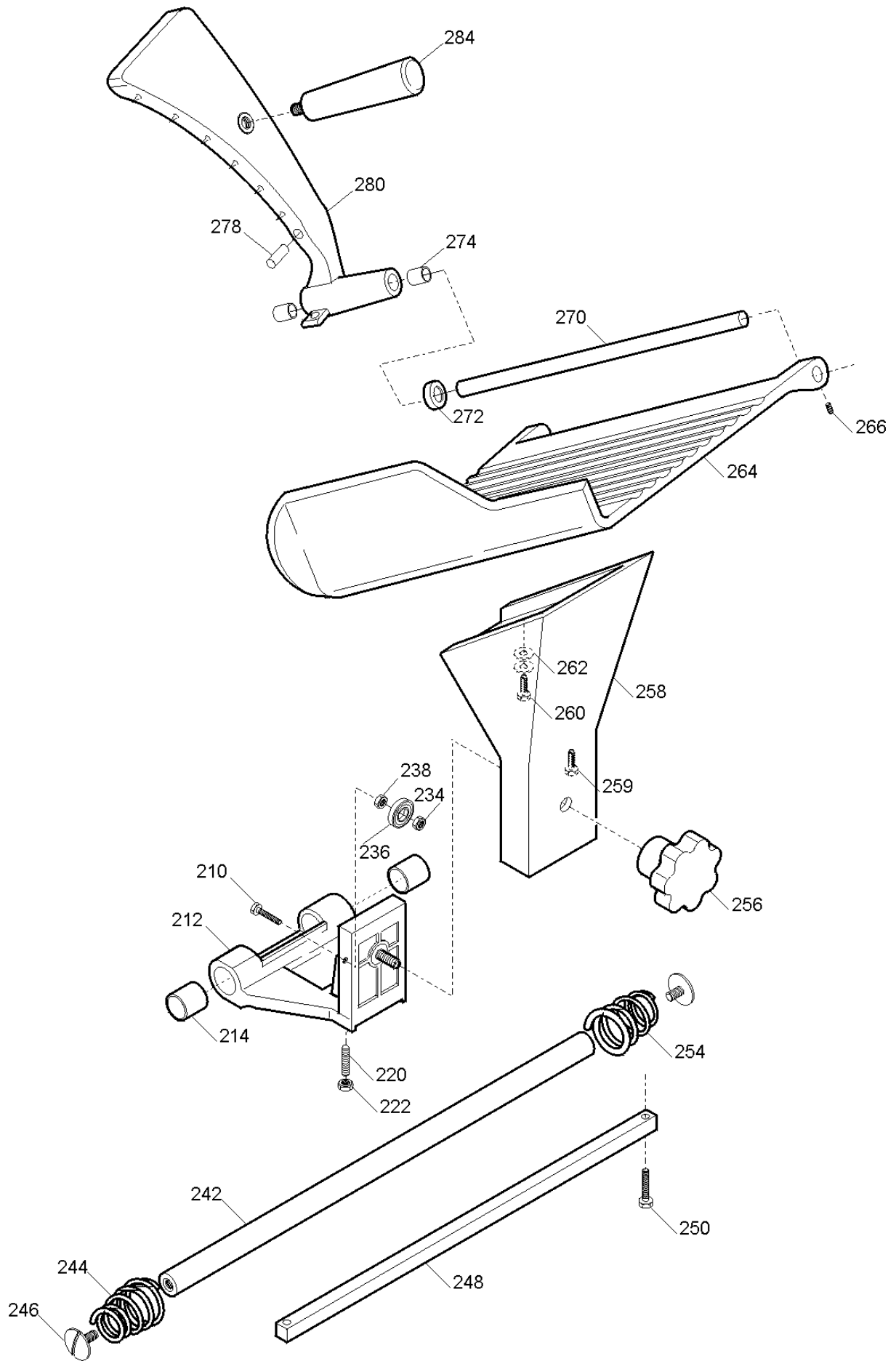







	REF	ART	COD
	04	FUSS M5 FUER AUFSCH. 	19560201
	06B	MESSERSCHUTZ MIRRA 250 AB 2009	195102025.09
	06A	MESSERSCHUTZ 250	195102025
	08	KNOPF FUER MESSERSCHUTZ	19021110
	14	LOCK NUT MIRRA 250 UNTIL 2001	19521610
	16	BLADE 250 40/3/210	18250403210
	16T	BLADE 250 - 40/3/210 TEFLON	18250403210T
	18	FERMO PARALAMA MRR 250 STA	19531350
	22	PULLEY FOR SLICER MRR	19700301
	24	RIEME TB2 345X8 Aufschn.	19310201
	32	BLADE GUARD TIE ROD FOR MIRRA_OLD	19530501
	34	TIE ROD KNOB M6X5 FOR MIRRA	19562502
	36	SLICE DEFLECTOR FOR MIRRA 250	19562202
	40	THICKNESS PLATE MIRRA 250C FROM '00	195103025
	56	RONDELLA SVASATA MRR	19346010
	58	SUP.VELA MRR 220 DAL'00 OSSIDATO	19510701
	62	LARGE WASHER	19563002
	64	GAUGE MAIN DEVICE MIRRA OLD	19500101
	65	MOVEMENT HEAD D8,5XHT2 FOR SLICER	19563201
	66	SLIDE GUIDE _ MIRRA	19540601
	78	SPRING FOR MIRRA 220-250	19390201/02
	80	PLATE SLIDE PIN D12X122,5 _ MIRRA	19530701
	90	SLIDE ROD, MRR	19336060
	92	CAM FOR MIRRA 220/275/300	19563505LG
	96	CORRUGATED WASHER 12	19342005
	102	THICKNESS ADJUSTING KNOB MIRRA	19562402







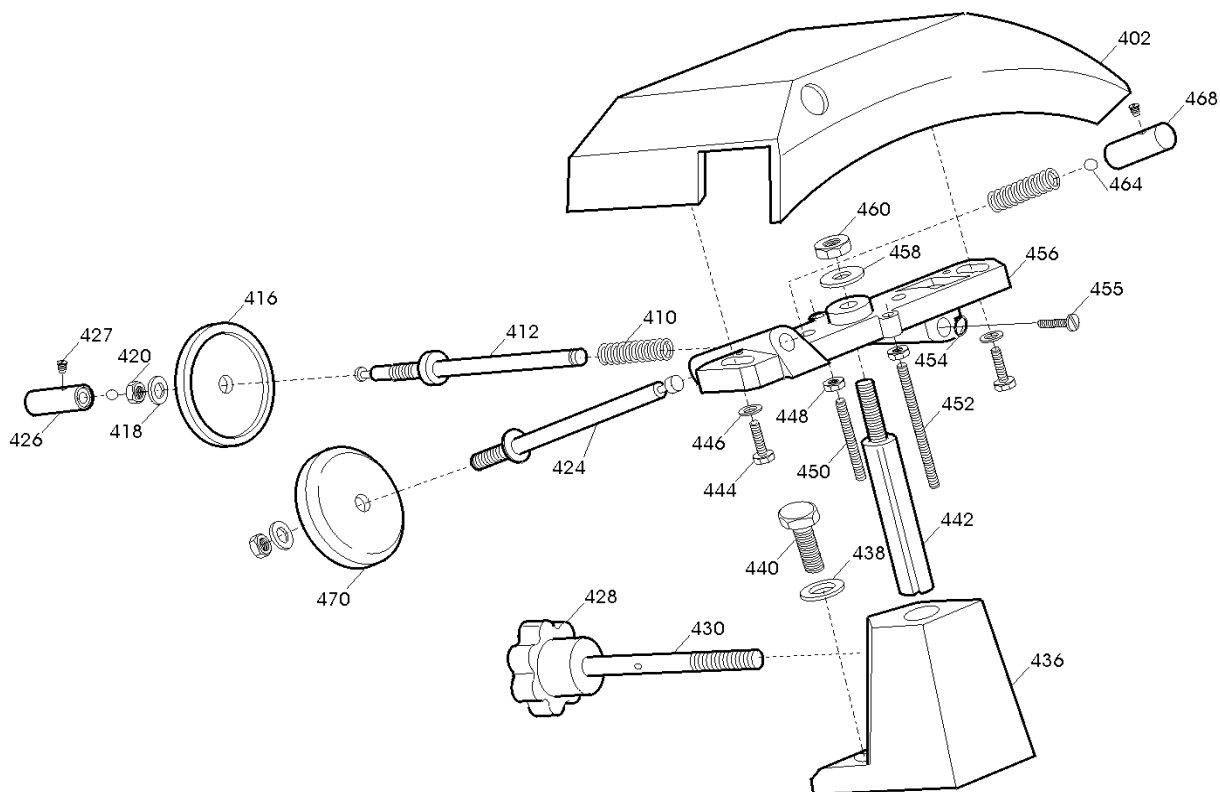











MIRRA 250

	REF	ART	COD
	212	CARRIAGE SLIDE FOR SLICER MIRRA	19500501
	214	BUSHING 18.20.20	19324108
	236	BEARING AUT.626	19320101
	242	SLIDE ROUND BAR _ MIRRA	19530601
	244/254	ROUND BAR SPRING MIRRA220-250	19390101
	246	ROUND BAR SCREW T.20_MIRRA	19335001
	248	SQUARE BAR _ MIRRA	19540101
	256	GRIFF MESSERSCHUTZ SCHRAUBE	19562504
	258	STEM FOR SLICER MIRRA	19510601
	264	PRODUCT PLATE MIRRA 250 C 4 HOLES	195104011
	272	RUBBER BUFFER, MEAT PRESS ROD_MIRRA	19560101
	274	BUSHING 10.12.10	19324101
	278	BUFFER D6,5X30 FOR MIRRA	19563208
	280	MEAT PRESS _ MIRRA 250 Y08	19510902.08
	284	GRIFF FUER MIRRA 220-250C	19562900







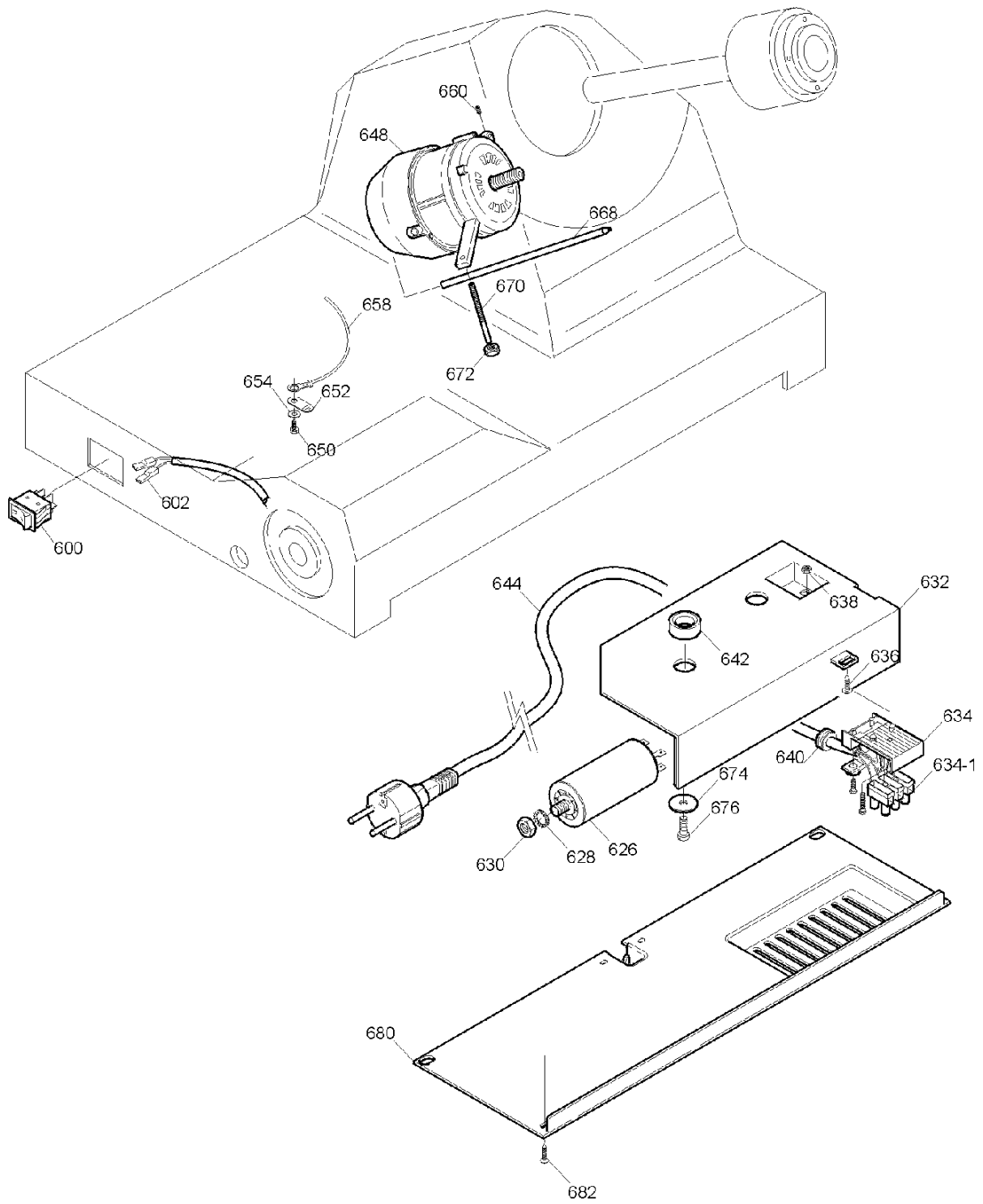







MIRRA 250

	REF	ART	COD
	402	SHARPENER COVER FOR SLICER 250	19511202
	410	SHARPENER SPRING _ SLICER 250-300	19390303
	412	DEBURRING PIN _ SLICER 250-300	19540703
	416	SCHLEIFSTEIN D.40 H.8 F.6 AUFSCHN 	19300201
	424	SHARPENING PIN _ SLICER 250-300	19540704
	426	DEBURRING BUTTON _ SLICER 250-300	19550203
	427	BUTTON SCREW _ SLICER 250-370	19335025
	428	FESTSTELLSCHRAUBE FUER AUFSCH.	19562602
	430	KNEBEL FUER AUFSCH.	19336010
	436	COLONNIN.250 ALL VERNICIATA	19511105
	442	SHARPENER ROD _ LEONARDO 250	19540402
	450	THREAD FOR SLICER	19336007
	456	SHARPENER FRAME _ SLICER 220-250	19500202
	468	SHARPENING BUTTON _ SLICER 250-300	19550202
	470	SCHLEIFSTEIN D.40 H.11 F.6 AUFSCHN 	19300101



MIRRA 250

	REF	ART	COD
	600	SCHALTER FUER AUFSCH. 	19410102
	626	KONDENSATOR 8 uF _ MIRRA/QUARZO	19410301
	632	ELECTRICAL HOUSING FOR SLICER	19563125
	634-1	TERMINAL BLOCK 3 POLES 27	19410822
	634	SUB-TERMINAL PA 228	19410820
	642	WIRE HOUSING SPACER RING	19561500
	644A	KABEL MIT STECKER 1-PH SCHUKO	19410502
	648	MOTOR 230/50 P.40 _ MIRRA	19403042
	668	S/S MOTOR ROD _ MIRRA	19540501
	670	STUD BOLT M5X40, MOTOR ROD 250	19336018
	680	BOTTOM COVER _ MIRRA 220-250	19563151